

Formulate 20' Flip - Kit 01

FLIP-01

Flip™ 20ft exhibits incorporate layered, staggered walls that are connected to create a unique, dimensional and versatile display. Double-sided graphics enable you to feature a different look, brand or messaging so you can **SPIN** from front to back or use as a creative space divider for a larger space. With an easy graphic change, you can also **FLIP** from top to bottom to create a new, different exhibit and look for your next event.



features and benefits:

- State-of-the-art 30mm aluminum tube frame with sturdy internal spigot assembly
- Easy to store and ship
- Quick to set up
- Kit includes: one frame, dye-sublimated zipper pillowcase graphics, and two wheeled molded OCE storage cases
- Lifetime hardware warranty against manufacturer defects

dimensions:

Hardware	Graphic
<p>Assembled unit: 252.245" w x 94.805" h x 21.365" d 6407mm(w) x 2408mm(h) x 543mm(d)</p> <p>Approximate weight (includes graphic): 72.68 lbs / 33 kg</p>	<p>Total visual area: Panel A: 43.607" w - 29.01" w x 94.48" h Panel B: 29.01" w - 43.607" w x 94.48" h Panel C: 114.384" w - 86.534" w x 94.48" h Panel D: 29.01" w - 43.607" w x 94.48" h Panel E: 43.607" w - 29.01" w x 94.48" h</p> <p>Please be sure to include a 2" bleed around the perimeter.</p>
<p>Shipping</p> <p>Shipping dimensions - ships in two cases: 2 OCE cases: 18" l x 18" w x 40" h up to 66" h 457mm(l) x 457mm(w) x 1016mm(h) up to 1675mm(h)</p> <p>Approximate shipping weight (with cases): 115 lbs / 52 kg</p>	<p>Refer to related graphic template for more information.</p> <p>Visit: www.exhibitors-handbook.com/graphic-templates</p>

additional information:

Graphic material:
dye-sublimated zipper pillowcase graphics



www.display-setup-animations.com

We are continually improving and modifying our product range and reserve the right to vary the specifications without prior notice. All dimensions and weights quoted are approximate and we accept no responsibility for variance. E&OE. See Graphic Templates for graphic bleed specifications.

Flip Kit 01 GRAPHIC OPTIONS

Double-sided graphics for the **SPIN** option work great for an island display or can be re-purposed at a different tradeshow. The graphics will be printed sewn together as a pillowcase.

Double-sided graphics for the **FLIP** option work great for utilizing the same booth for multiple tradeshows or events. The graphics will be printed sewn together as a pillowcase. Please note that the "flipped" backside of the graphics will be sewn upside down. Also, one side will have zippers on the bottom but when flipped, they will be located on the top.

Double-sided Option 3 **SPINS & FLIPS** in orientation and requires purchasing 2 sets of single sided graphics. All graphics are printed on our power stretch.

Step 1: Pick a desired front view for your kit.

If only ordering a single sided graphic, you will be done completing this form after this step.

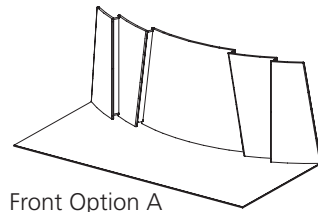

Front Option A

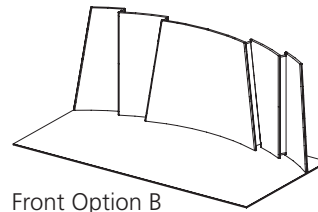

Front Option B

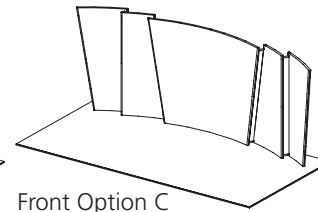

Front Option C

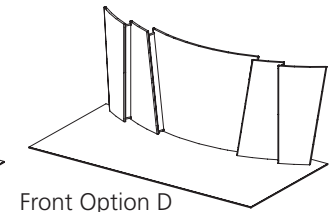

Front Option D

Step 2: If only ordering a double-sided graphic, please select one of the options for the backside listed below.

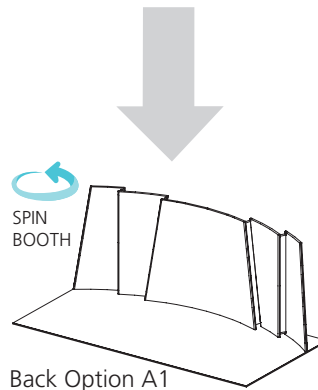

Back Option A1

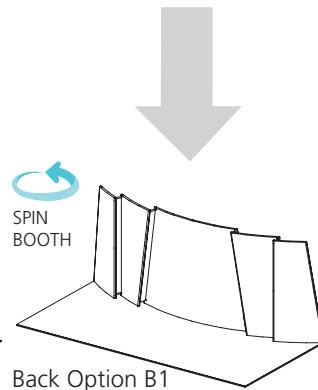

Back Option B1

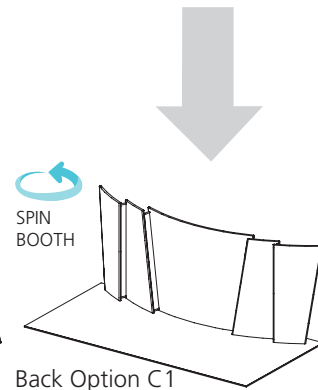

Back Option C1

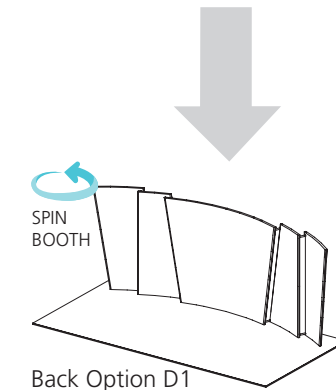

Back Option D1

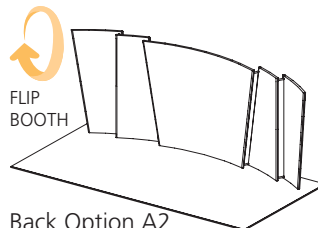

Back Option A2

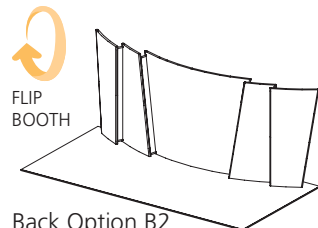

Back Option B2

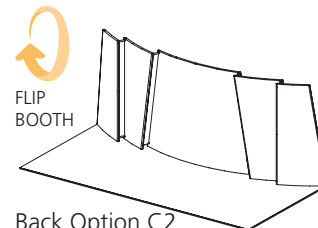

Back Option C2

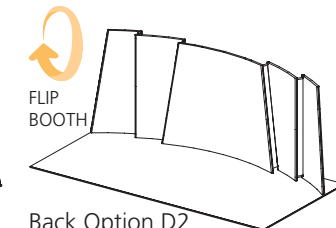

Back Option D2

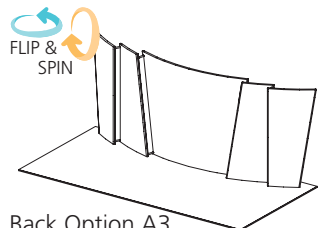

Back Option A3

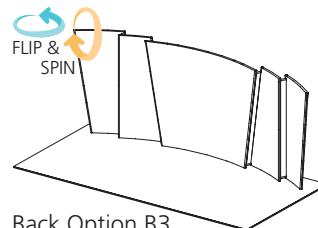

Back Option B3

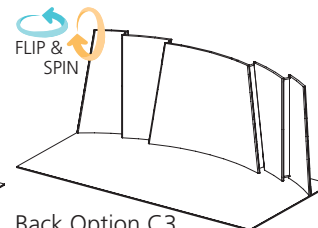

Back Option C3

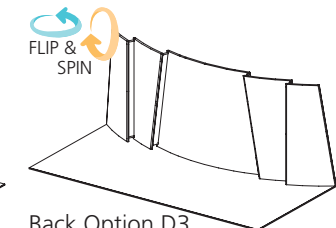

Back Option D3

*Option 3 requires 2 sets of single sided graphics

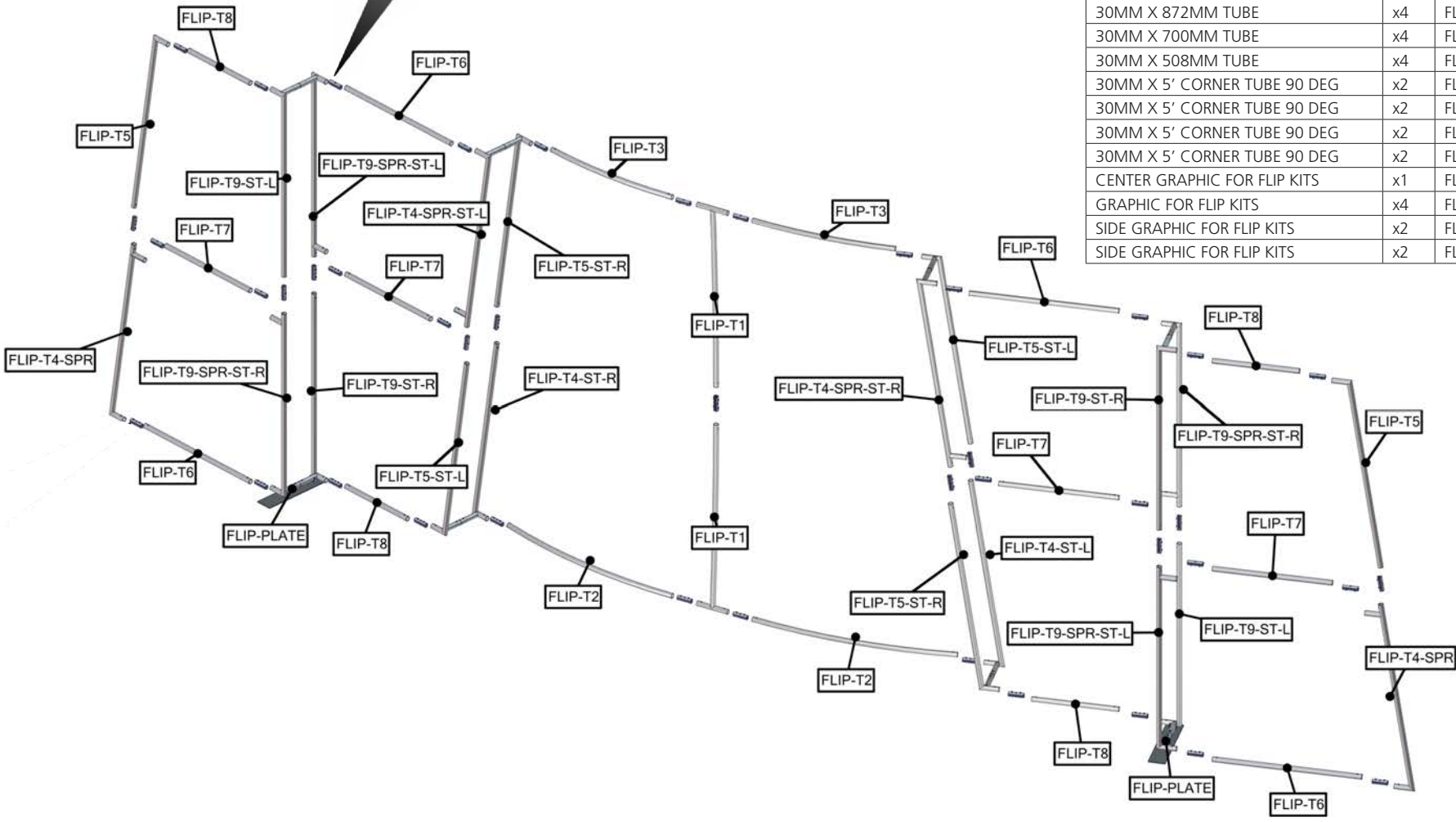
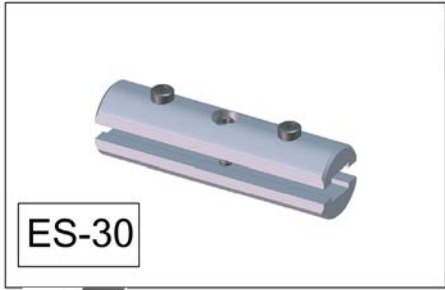

Parts Included		
Part Label	Qty	Part Code
EXPANDING SPIGOT FOR 30MM TUBE	x52	ES-30
STEEL PLATE FOR FLIP KIT	x2	FLIP-PLATE
30MM X 5' CORNER TUBE	x2	FLIP-T
30MM X 5' CURVED SPREADER TUBE	x2	FLIP-T1
30MM X 5' CURVED TUBE	x2	FLIP-T2
30MM X 4' CURVED TUBE	x2	FLIP-T3
30MM X 5' CORNER TUBE 82 DEG	x2	FLIP-T4-SPR
30MM X 5' CORNER TUBE 82 DEG	x1	FLIP-T4-SPR-ST-R
30MM X 5' CORNER TUBE 82 DEG	x1	FLIP-T4-SPR-ST-L
30MM X 5' CORNER TUBE 82 DEG	x1	FLIP-T4-ST-R
30MM X 5' CORNER TUBE 98 DEG	x2	FLIP-T5-ST-R
30MM X 5' CORNER TUBE 98 DEG	x2	FLIP-T5-ST-L
30MM X 5' CORNER TUBE 98 DEG	x2	FLIP-T5
30MM X 872MM TUBE	x4	FLIP-T6
30MM X 700MM TUBE	x4	FLIP-T7
30MM X 508MM TUBE	x4	FLIP-T8
30MM X 5' CORNER TUBE 90 DEG	x2	FLIP-T9-ST-R
30MM X 5' CORNER TUBE 90 DEG	x2	FLIP-T9-SPR-ST-L
30MM X 5' CORNER TUBE 90 DEG	x2	FLIP-T9-SPR-ST-R
30MM X 5' CORNER TUBE 90 DEG	x2	FLIP-T9-ST-L
CENTER GRAPHIC FOR FLIP KITS	x1	FLIP-G2
GRAPHIC FOR FLIP KITS	x4	FLIP-G1
SIDE GRAPHIC FOR FLIP KITS	x2	FLIP-G4
SIDE GRAPHIC FOR FLIP KITS	x2	FLIP-G3

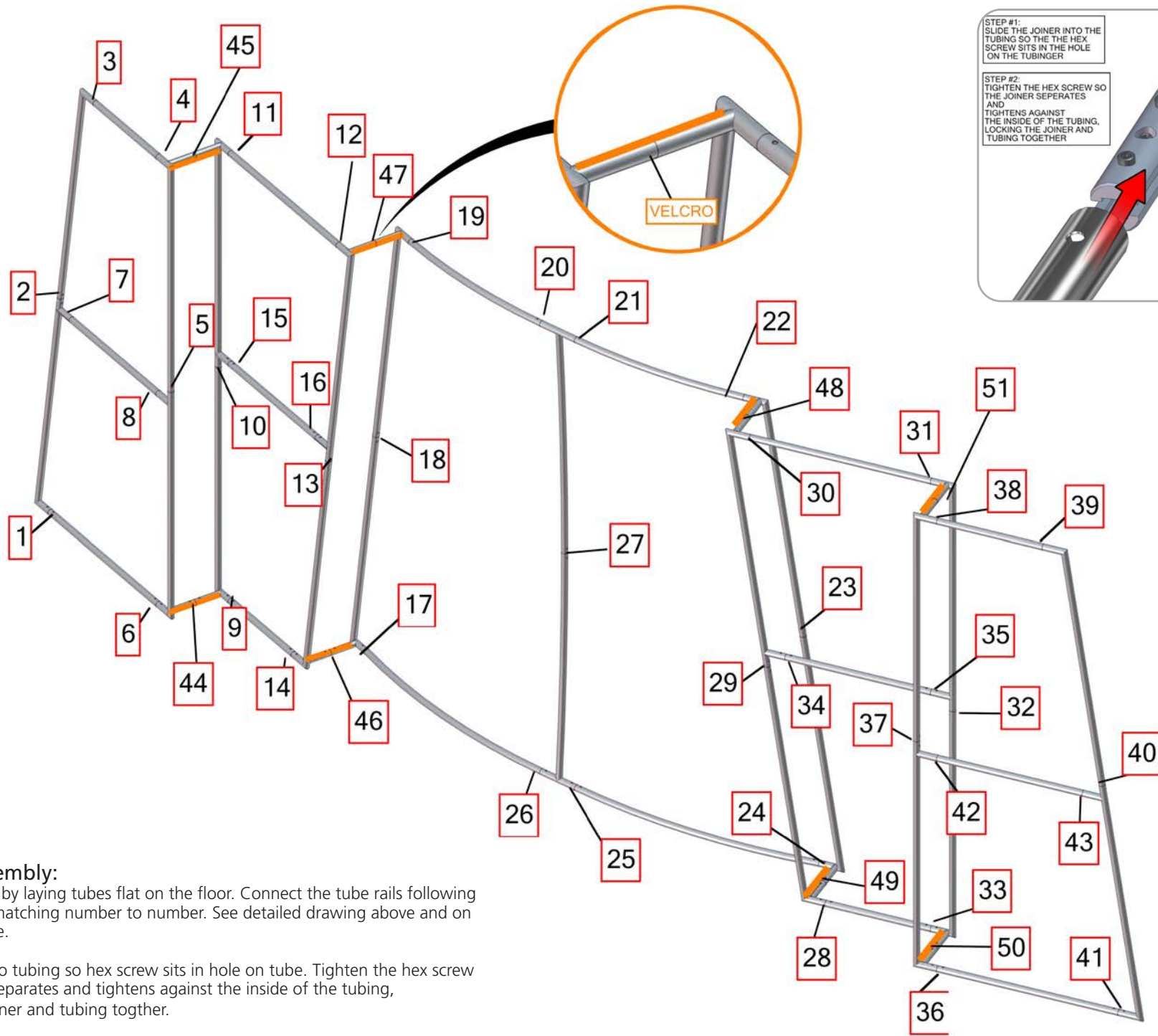

**Flip Kit 01
Frame Assembly:**

Assemble unit by laying tubes flat on the floor. Connect the tube rails following the labels by matching number to number. See detailed drawing above and on following page.

Slide joiner into tubing so hex screw sits in hole on tube. Tighten the hex screw so the joiner separates and tightens against the inside of the tubing, locking the joiner and tubing together.

Flip Kit 01

Center Section Assembly:

Step 1: Slide joiner into tubing so hex screw sits in hole on tube.

Step 2: Tighten the hex screw so the joiner separates and tightens against the inside of the tubing, locking the joiner and tubing together.

Step 3: Zip fabric graphic closed around frame.

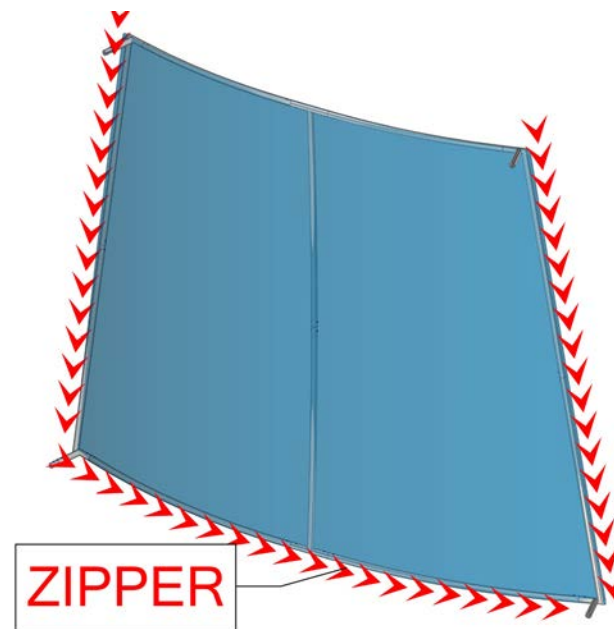
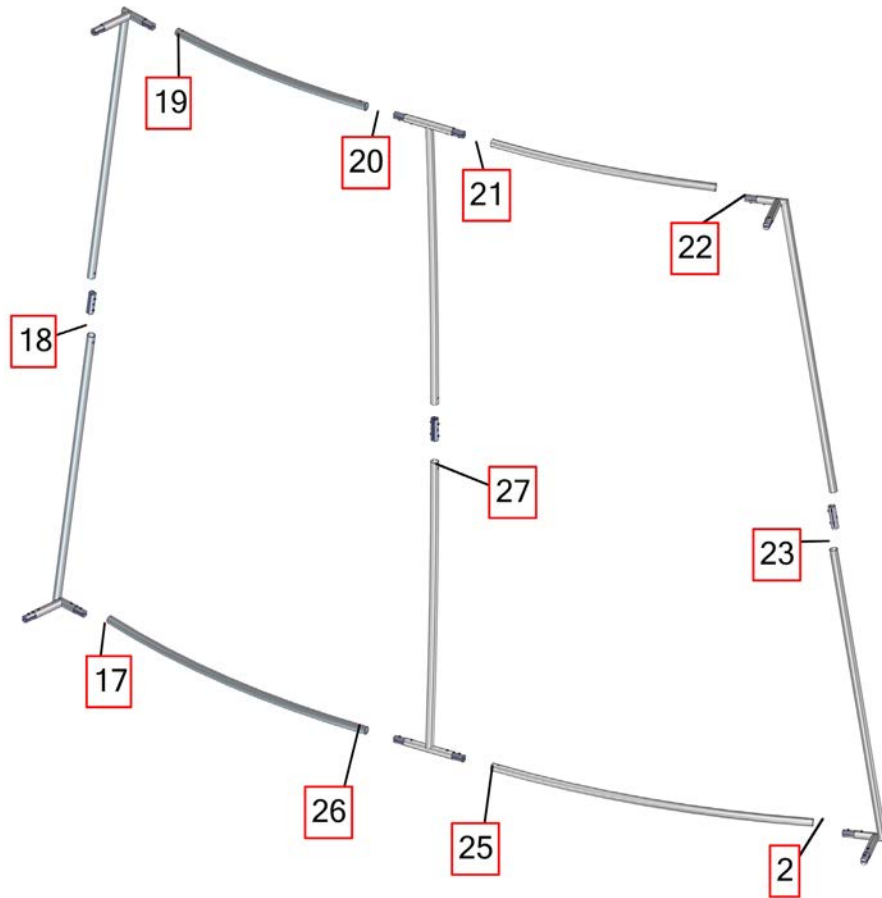
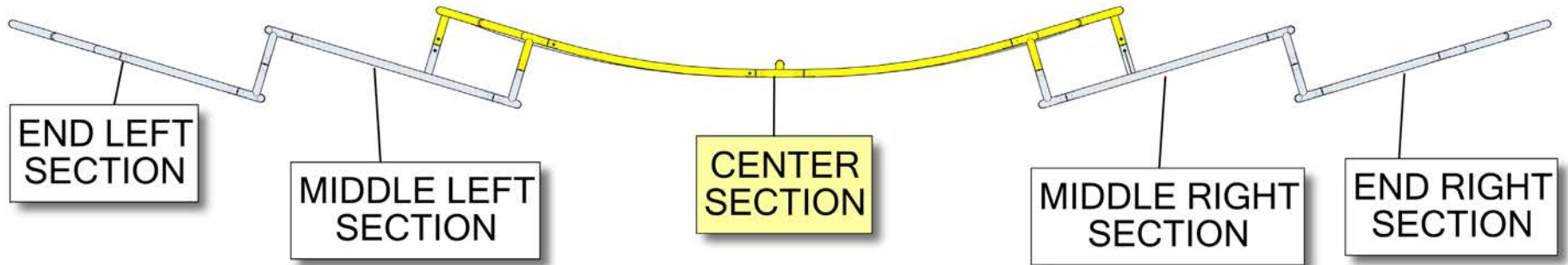

Flip Kit 01

Middle Left & Middle Right Section Assembly:

Step 1: Slide joiner into tubing so hex screw sits in hole on tube.

Step 2: Tighten the hex screw so the joiner separates and tightens against the inside of the tubing, locking the joiner and tubing together.

Step 3: Zip fabric graphic closed around both frames.

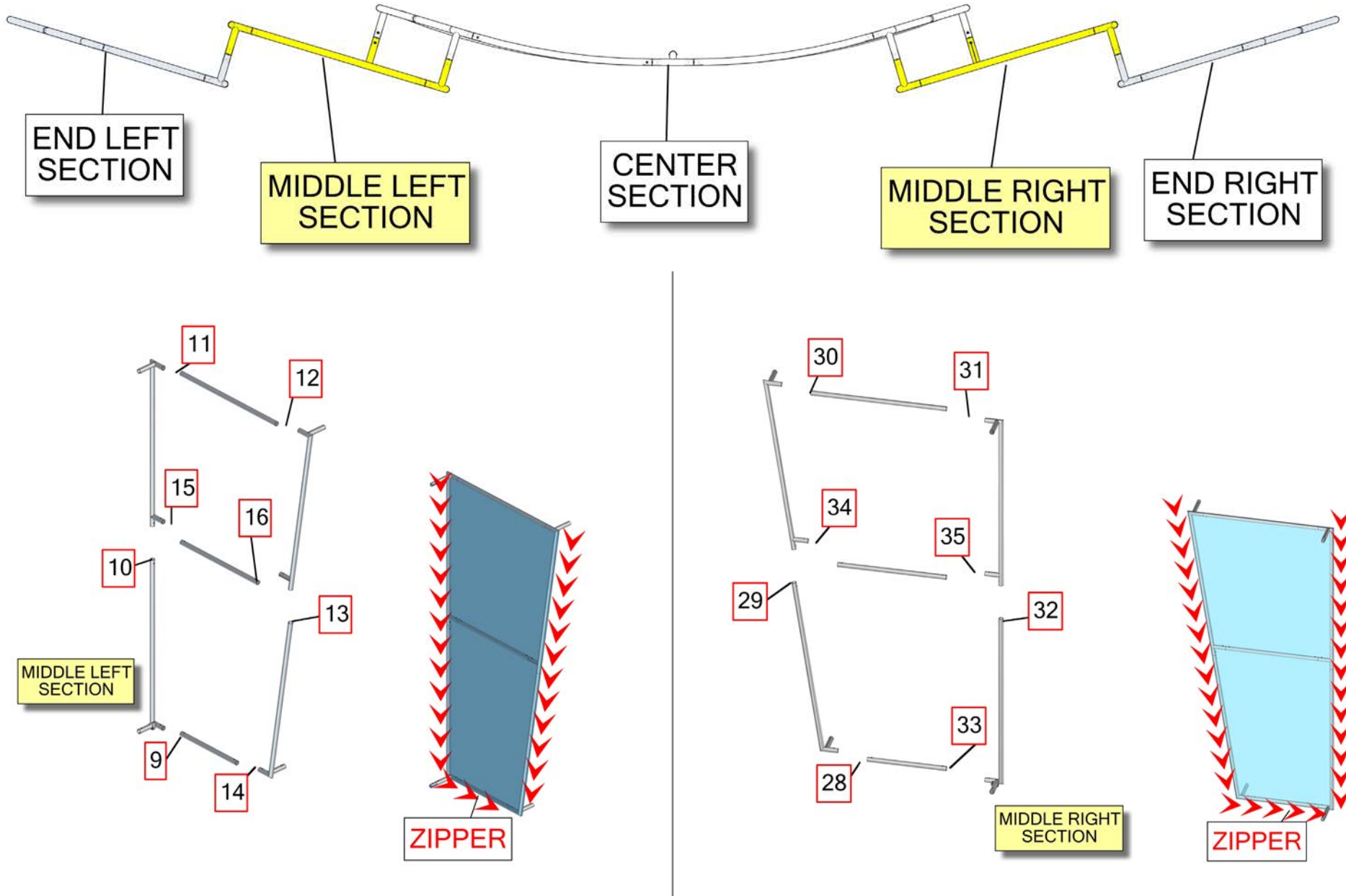

Flip Kit 01

End Left & End Right Section Assembly:

Step 1: Slide joiner into tubing so hex screw sits in hole on tube.

Step 2: Tighten the hex screw so the joiner separates and tightens against the inside of the tubing, locking the joiner and tubing together.

Step 3: Zip fabric graphic closed around both frames.

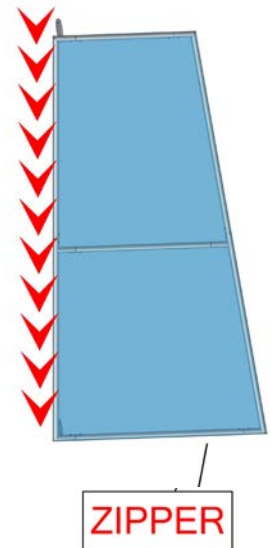
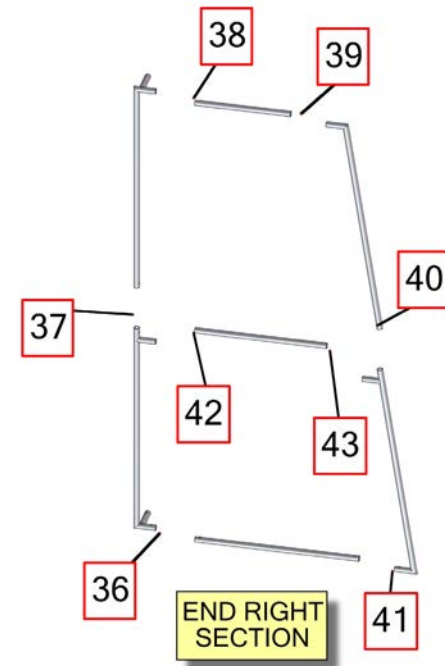
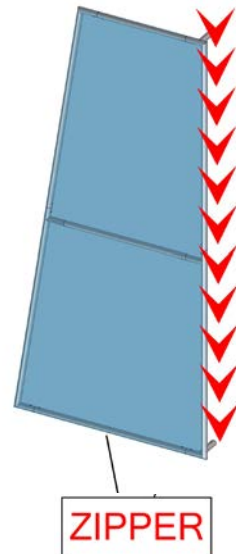
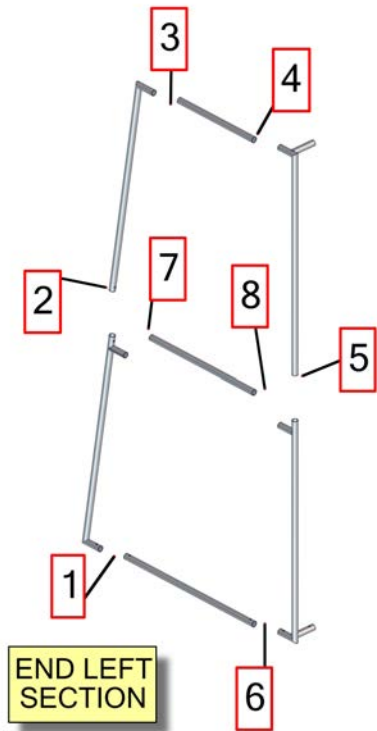
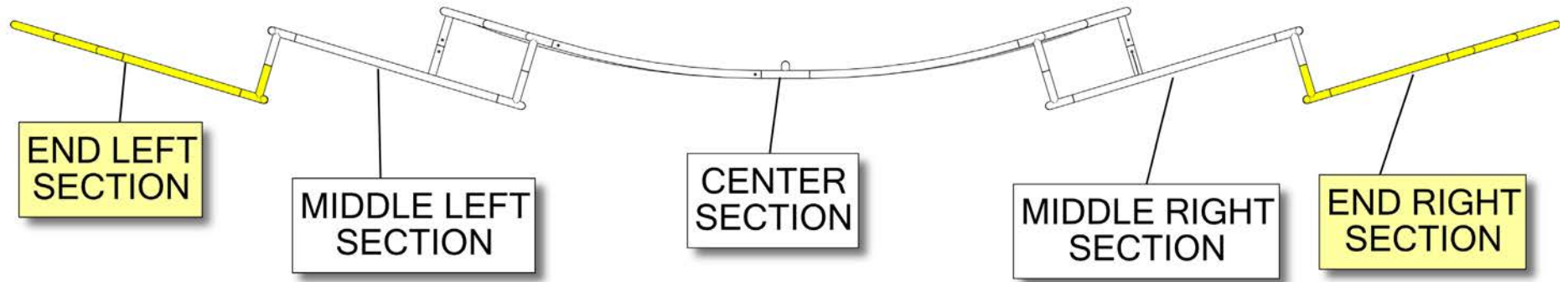

Flip Kit 01

Connect the end sections to the middle sections and then the middle sections to the center section. Fabric graphic should already be on each individual panel. Connect the tube rails by pressing the push pin buttons in and slide over (see detailed drawing below) following the number labels listed matching number to number.

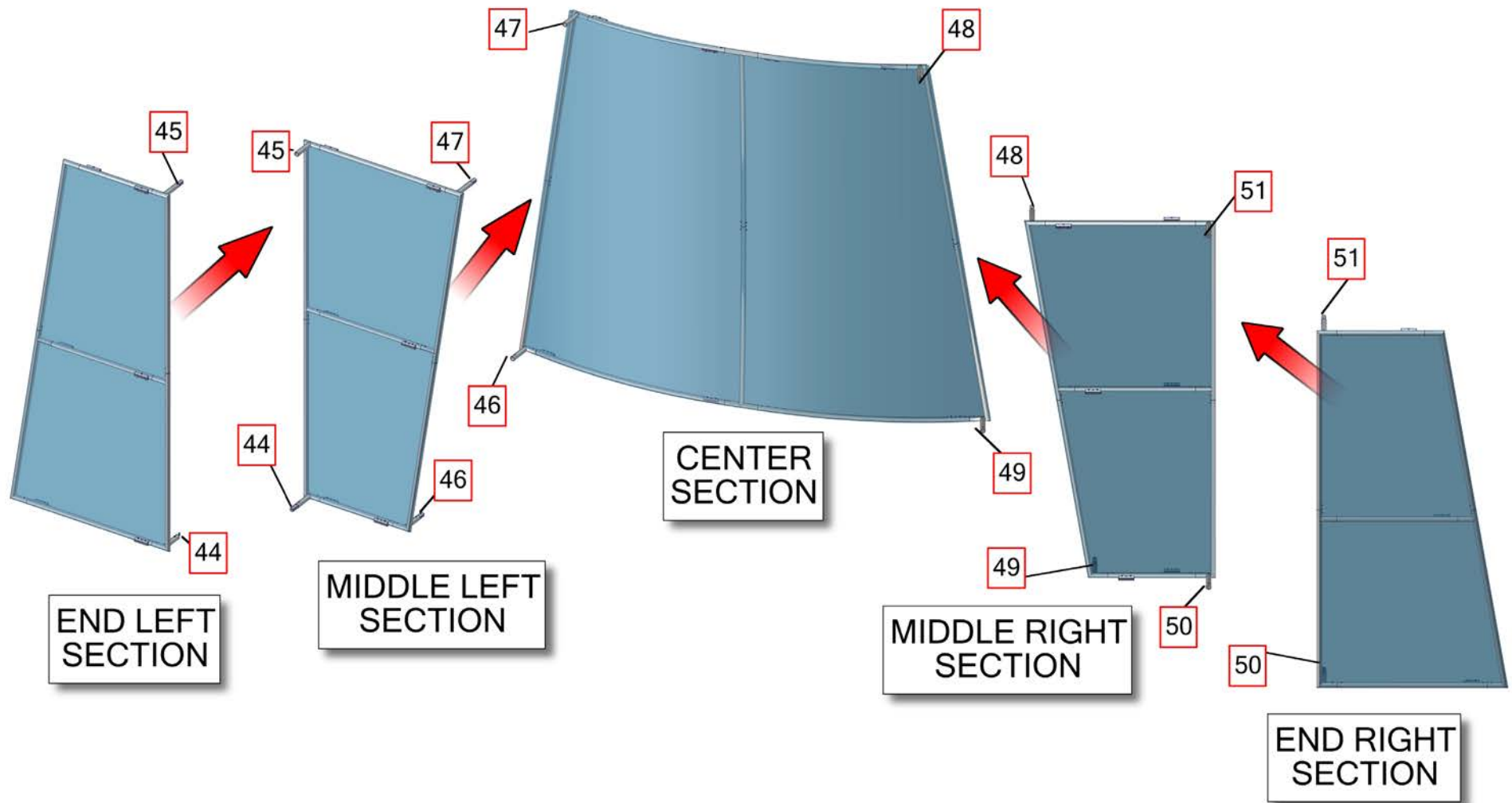

Flip Kit 01

Step 1: Install fabric side panels with velcro on top & bottom as shown in diagram below.

Step 2: Attach FLIP-PLATE feet for support in locations as shown.

